



EA-K1 Series Keypad Access Controller

Electronic access

- **Single & 2-door**
- **Simple PIN programming**
- **LED indicator and audible feedback for programming and lock status**
- **Programmable PIN length supports up to 90,000,000 combinations**
- **Non-volatile memory retains data after power is removed**
- **Programmable door release time**
- **Surface or rear mount**
- **Custom color and logo options**

Southco's self-contained keypad controllers provide basic PIN access control without the need to carry physical credentials. Simply supply 12 volt DC power and connect the output to any *SOUTHCO*[®] electromechanical latch for a complete electronic access solution. Now available with output for 2 doors.

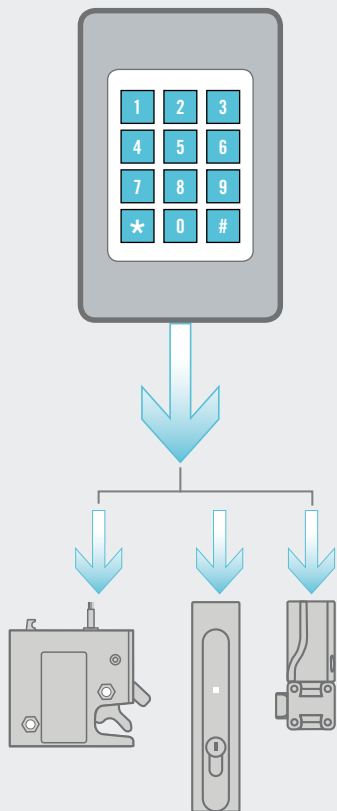

Additional Features

Lockout output provides alarm output after multiple failed access code attempts, programmable from 1-9 attempts. (1-door controller only)

Tamper switch provides output if keypad is removed from mounted surface.

Auxiliary input allows for additional remote input signal to open lock for programmed time.

Other options available. For complete details on variety, part numbers, installation and specification, go to



www.southco.com/EA-K1

Dimensions in millimeters (inch) unless otherwise stated

southco[®]
CONNECT · CREATE · INNOVATE

EA-K1 Series Keypad Access Controller

Electronic access



Surface Mount

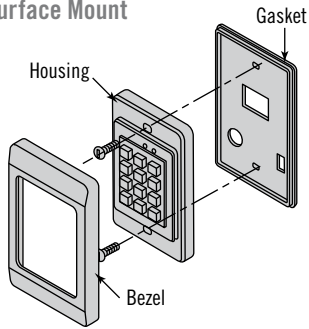

Rear Mount

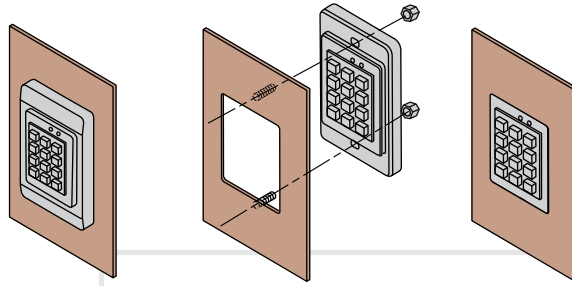

ACTUAL SIZE

Bezel Attached

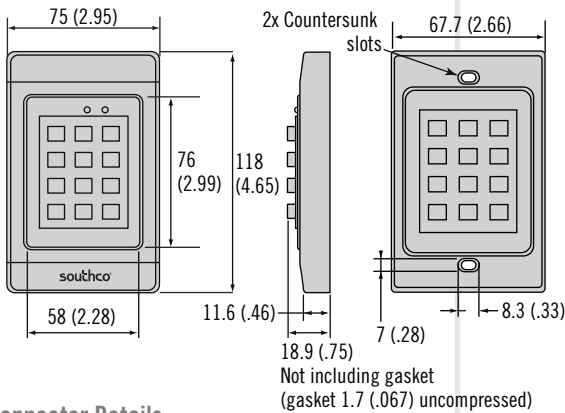

Without Bezel

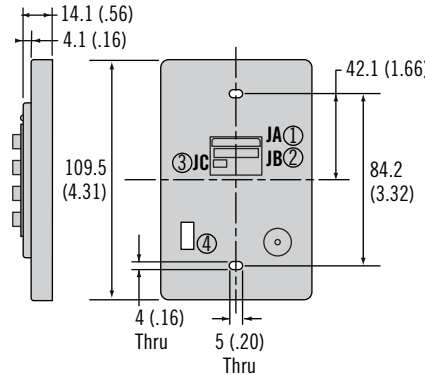

Connector Details

(Note: Mating connectors with approximately 160mm (6.3) of wiring, stripped and tinned provided with keypad).

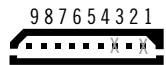

- JA (Blue)
For door access
- 9 (Red) ← +12 VDC
 - 8 (Black) ← Ground
 - 7 (Brown) ← NO
 - 6 (Orange) → COM
 - 5 (Yellow) → NC
 - 4 (Green) ← Auxiliary input
 - 3 (Blue) ← X
 - 2 (Purple) ← Auxiliary input
 - 1 (Grey) ← X
- Relay output A (Max. 2A / 30 VDC)

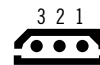

- JB (White)
tamper switch output
- 3 (Blue) → NC
 - 2 (Green) → NO
 - 1 (Yellow) ← COM

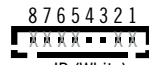

- JC (White)
Lockout alarm output (1-door controller)
Door 2 access (2-door controller)
- 4 (Green) ← (NO)
 - 3 (Blue) → (COM)
- Relay output B (Max. 2A / 30 VDC)

Material & Finish

Polycarbonate and ABS Plastic

Electrical Specifications

Access Code Length:

Programmable

4 to 8 digits (1-door controller),
5 to 8 digits (2-door controller)

Monitoring Inputs: Auxiliary, case tampering

Power: 12 VDC 25mA in standby,
55mA working current (typical)

Operating Temperature: 0-50 °C

Operating Humidity: 20-90% RH,
no condensation

Connectors:

Connector with approx. 160mm (6.3) of wiring, stripped and tinned provided with keypad

- 1 JA Door access connector (blue 9-pin)
- 2 JB Lockout alarm connector (1-door controller) Door 2 access connector (2-door controller) (white 8-pin)
- 3 JC Tamper switch output connector (blue 3-pin)
- 4 Tamper switch

Part Number Selection

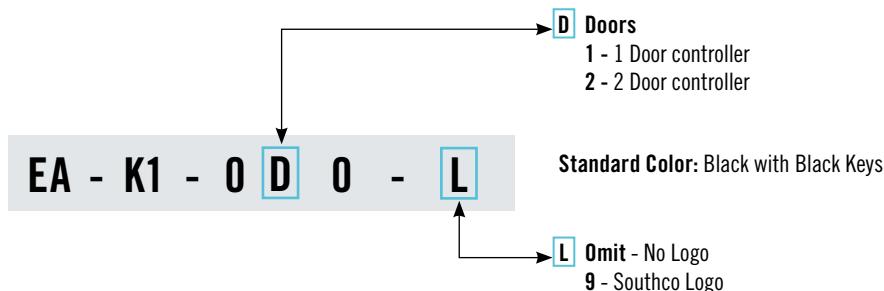

Dimensions in millimeters (inch) unless otherwise stated



Global Corporate Headquarters and Americas Customer Service & Technical Support Center
Tel: (1) 610-459-4000 · Fax: (1) 610-459-4012 · www.southco.com · info@southco.com



Other options available. For complete details on variety, part numbers, installation and specification, go to

www.southco.com/EA-K1

© Southco EA-K1 NA 08-10

EA-K1 Keypad

Instructions for Programming EA-K1-01x

Package Contents

- Standalone keypad
- Wire harness for JA connector (9-wires with blue connector)
- Wire harness for JB connector (8-wires with white connector)
- Wire harness for JC connector (3-wires with blue connector)
- 1 diode
- 2 mounting screws
- Instruction guide

EA-K1-01x Standalone Keypad Access Controller

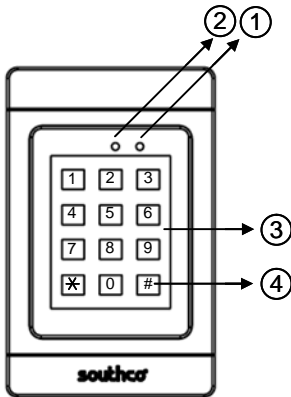

1. Power LED
2. Status LED
 - a. Solid Green: waiting for key code
 - b. Flashing Green: release door
 - c. Solid Red: lockout
 - d. Flashing Green and Red: programming
3. Keypad
4. Return to ready state key

Features

- Supports seven user access codes
- Programmable door release time (1 to 99 seconds)
- Programmable lockout attempts (1 to 9)
- Programmable lockout time (1 to 99 seconds)
- Programmable user and supervisor code length (4 to 8 digits)
- LED indicators: Power and Status
- Non-volatile memory will retain data when power is removed
- Tamper switch

Specifications

| | |
|------------------------|---|
| Access Code Length: | Programmable 4 to 8 digits |
| Monitoring Inputs: | Request-to-Exit (REX) button Tamper Switch |
| Supply Voltage: | 12 ± 10% VDC |
| Standby Current: | 25mA (max, no attached devices) |
| Operating Current: | 65mA (max, no attached devices) |
| Operating Temperature: | 0-50 °C |
| Operating Humidity: | 20-90% RH, No condensation |
| Dimensions: | 118 mm x 75 mm x 19 mm |

NOTE: For indoor use only.

Quick Start Guide

This section describes how to wire the keypad and program it with one user access code. In this section, it is assumed that the keypad is set to its default parameters (it is shipped with its default parameters). By default, no user access codes are enrolled and the supervisor code is 12345678.

Basic Wiring

Wiring the keypad for normal operation requires a connection to a 12 VDC power supply and a connection to a latch. Refer to the wiring diagram at the end of these instructions for more detail.

1. Plug the 9-pin blue connector (JA) into the keypad. This is the only connector you will need for this basic setup.
2. Connect the red wire to a +12 VDC source.
3. Connect the black wire to GND at the power supply.
4. Wire the relay by connecting the brown wire to +12 VDC (or the voltage your application requires <30 VDC)
5. (Typically the normally open (NO) relay output will be used.)
Connect the orange wire to the control input of the latch.
 - If using the normally closed (NC) output, then connect the yellow wire to the control input of the latch.

Specific applications may require slightly different connections. Please refer to the wiring diagram at the end of these instructions for detailed descriptions of each lead.

Once the keypad is powered, the Power LED should be illuminated indicating the unit is ready for use or in the "ready state." To return to the ready state after keys have been typed, press the # key.

Basic Programming

To enroll a four digit user access code, choose any four digit code that does NOT begin with "9", then:

1. Enter the programming code to enroll the first user access code (9991).
2. Enter the supervisor access code (default 12345678).
3. Enter the new four digit user access code.

Now you have set up one user code.

In typical operation the keypad will function as shown below.

Normal Operation

In normal operation the user can enter an access code. If the access code is accepted, the Status LED will blink green and the door actuator will be released for the time period specified. If the password is not accepted, the Status LED will turn red and the unit will beep three times.

Quick Start Example:

This example sets up a user access code to 4321

1. Enter the programming code for the first user access code: 9991.
2. Enter the default supervisor code: 12345678.
3. Enter the new user access code: 4321. Now the new user access code is programmed.

To restore the keypad to default settings after completing this example, type 9990 followed by the default supervisor code. The user access code that was programmed in the example will be erased.

EA-K1 Keypad

Instructions for Programming EA-K1-01x

Programming the Keypad

Two schemes are used in programming the keypad: standard and extended. Each process is illustrated below in flow charts. All programming functions are initiated by entering a programming code followed by the correct supervisor code. *All programming codes begin with a nine.* See the table below for programming codes.

| Code | Description |
|-----------|--|
| 9990 | Restore default settings |
| 9991-9997 | Program user access codes |
| 9801-9899 | Program door release time |
| 9701-9799 | Program keypad lockout time |
| 9601-9609 | Program number of allowed failed attempts |
| 9504-9508 | Program number of digits for user access and programming codes |
| 9998 | Program eight digit supervisor code |

Standard Process Map

This process diagram is used when programming the parameters listed below.

| Code | Description |
|-----------|--|
| 9990 | Restore default settings |
| 9801-9899 | Program door release time |
| 9701-9799 | Program keypad lockout time |
| 9601-9609 | Program number of allowed failed attempts |
| 9504-9508 | Program number of digits for user access and programming codes |

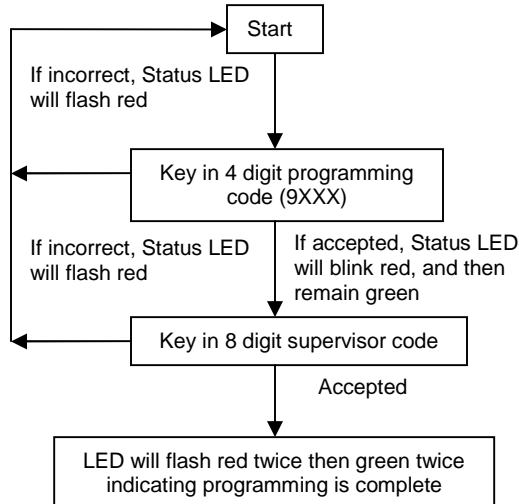

Extended Process Map

This process diagram is used when programming the parameters listed below.

| Code | Description |
|-----------|-------------------------------------|
| 9991-9997 | Program user access codes |
| 9998 | Program eight digit supervisor code |

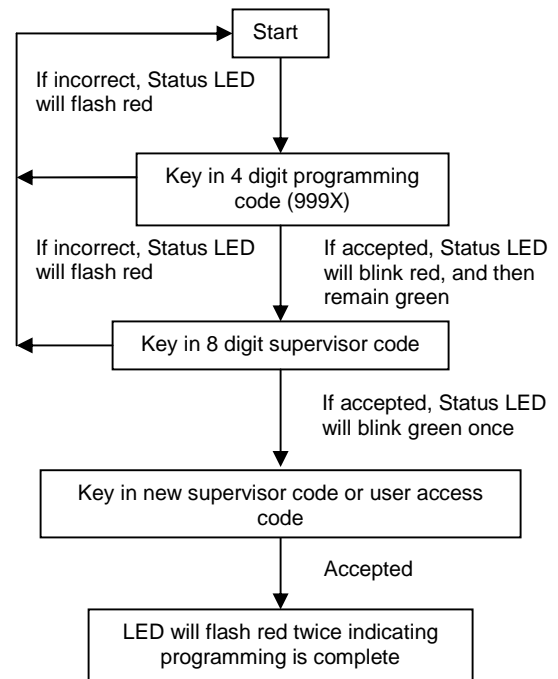

Note: Once a function code has been accepted, the Status LED will remain illuminated for approximately ten seconds while it waits for the supervisor access code. If ten seconds elapse with no input, the keypad will return to normal mode.

Programming Codes

9990: Restore defaults (standard process map)

The controller can be set to its factory default settings. To restore the default settings:

1. Enter the programming code 9990.
2. Enter the supervisor access code (default 12345678).

The Status LED will flash red twice and then turn off indicating the programming is complete. After restoring the keypad, parameters will be set to the following defaults:

| Default Settings | |
|-------------------------|-----------|
| Access code length | 4 digits |
| Allowed failed attempts | 2 times |
| Keypad lockout time | 5 seconds |
| Door release time | 5 seconds |
| Supervisor code | 12345678 |

9991 – 9997: Program user access codes (extended process map)

Seven user access codes can be programmed using the supervisor code and the function codes 9991 through 9997. The user access codes can be any combination of digits, except the user access codes **cannot** begin with nine (nine is reserved for programming codes). To program an access code:

1. Enter one of the seven programming codes numbers (i.e. 9991 through 9997). The Status LED will flash green, flash red, and then remain green.
2. Enter the eight digit supervisor code. The Status LED will blink once.

EA-K1 Keypad

Instructions for Programming EA-K1-01x

- Enter the four digit user access code desired. The Status LED will flash red twice, and then turn off.

To set another user access code, use the next available programming code 9992, 9993, etc. To change a user access code, use the programming code that it is paired with. For example, if 9992 was used to assign the user access code 1234, you may change this user access code to 4321 by using the programming code 9992. It is recommend that the supervisor keep careful records of each user access programming code, the corresponding user access code, and the individuals who use this code.

9601 – 9609: Program allowed failed attempts (standard process map)

The number of allowed failed attempts can be programmed from one to nine. This is the number of times the wrong access code can be entered (this includes both user access codes and the supervisor pass code). If this number is reached, the keypad will lock out all operation for the specified lockout time. This feature is designed to prevent trial and error tampering. To change from the default of two:

- Enter “960x” where “x” is the number of allowed failed attempts and can range from 1 to 9. The Status LED will flash green, flash red, and then become solid green.
- Enter the eight digit supervisor code. The Status LED will flash red, then green before turning off.

9701 – 9799: Program keypad lockout time (standard process map)

The duration of the keypad lockout time can be programmed from 1 to 99 seconds. While locked out, the keys are not functional and The Status LED is illuminated solid red.

The keypad lockout time code is 97tt, where “tt” is the desired keypad lockout time in seconds.

For example, if the desired keypad lockout time is 30 seconds, the programming code is 9730.

To change from the default of five seconds:

- Enter “97tt”, where “tt” is the lockout code in seconds. The Status LED will flash green, flash red, and then become solid green.
- Enter the eight digit supervisor code. The Status LED will flash red, then green before turning off.

9801 – 9899: Program door release time (standard process map)

The length of time the door is released can be programmed from 1 to 99 seconds.

The door release time code is 98tt, where “tt” is the desired door release time in seconds.

For example, if the desired door release time is one minute, the programming code is 9860.

To change from the default of five seconds:

- Enter “98tt”, where “tt” is the door release code in seconds. The Status LED will flash green, flash red, and then become solid green.
- Enter the eight digit supervisor code. The Status LED will flash red, then green before turning off.

9998: Program eight digit supervisor code (extended process map)

⚠ CAUTION: If the supervisor access code is lost, forgotten or incorrectly entered while programming, the keypad cannot be restored to default settings, no new programming codes may be entered, and the lost supervisor access code cannot be recovered. Without the supervisor code, the keypad will continue to function, however no programming changes can be made.

Please change the eight digit code to a number you will remember. If the number is lost it cannot be recovered. To change the supervisor code:

- Enter “9998”. The Status LED will flash green, blink red, and then become solid green.
- Enter the current eight digit supervisor code. The Status LED will blink once.
- Carefully* enter the new eight digit key code. The Status LED will flash red, then turn off.

9504 – 9508: Program number of digits for user access and programming codes (standard process map)

⚠ CAUTION: This is an advanced feature; it increases the complexity of programming the keypad. It is recommend only to switch from the default setting of four digit user access codes if absolutely necessary.

The number of digits in the user access and programming codes can be changed from the default of four. The number of digits set here is the number of digits the keypad accepts for all codes, including function codes. If the number of digits is increased, then the function code must be padded with zeroes. For example if the number of digits has been changed to six, the code to reset the controller (9990) must be entered as “999000”. The supervisor code need not be adjusted; it is always an eight digit code.

NOTE: Any previously assigned user access codes will be erased when the number of digits is changed.

To change from the default of four digits:

- Enter “950d”, where “d” is the number of digits in the user access code (ranging from 4 to 8). The Status LED will flash green, flash red, and then become solid green.
- Enter the eight digit supervisor code. The Status LED will flash red, then green before turning off.

Other Features

Lockout Alarm (JB Connector)

The EA-K1-01x controller provides a relay output that is activated whenever:

- the keypad is locked out due to reaching the number of allowed failed attempts, or
- the security monitor input is active

This will cause the relay to close (i.e. drive the voltage at the COM terminal) for the programmed keypad lockout time.

Auxiliary Input

The EA-K1-01x controller has an auxiliary input that can be driven by an external device. Pin 6 from the JA connector (green wire) is the auxiliary input. When the auxiliary input is 12VDC, the controller will grant access for the programmed access time.

EA-K1 Keypad

Instructions for Programming EA-K1-01x

Security Monitor Input

The EA-K1-01x has a security monitor input that can be driven by an external device. Pin 8 from the JA connector (purple wire) is the security monitor input. When the security monitor input is driven LOW (0V), the lockout alarm will be activated and the keypad locked out for the programmed keypad lockout time. NOTE: The Status LED will not illuminate if the security monitor input is active.

Tamper Switch

The JC connector can be used to monitor the status of the tamper switch. When the tamper switch is closed, the NO signal will be driven to the same voltage level as the COM signal. When the tamper switch is open, the NC signal will be driven to the same voltage level as the COM signal.

Wiring Multiple Controllers

A diode is provided with the EA-K1-01x controller. The diode allows for a keypad to be isolated when multiple controllers are connected to the same latch. Refer to the figure below for wiring details when using the diode when using multiple controllers.

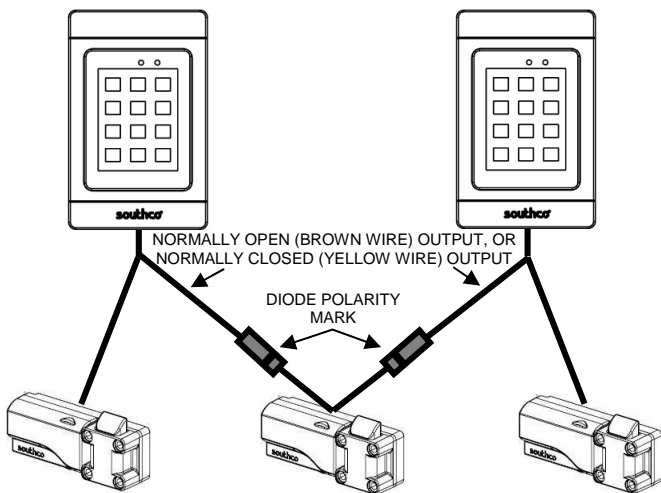

Connecting to an Inductive Load

A diode is provided with the EA-K1 controller. This diode should be used when connecting to a device with an inductive load (for example, a relay or door strike) to protect the controller from a reverse voltage spike. The diode should be placed in parallel with the coil, as shown in the figure below.

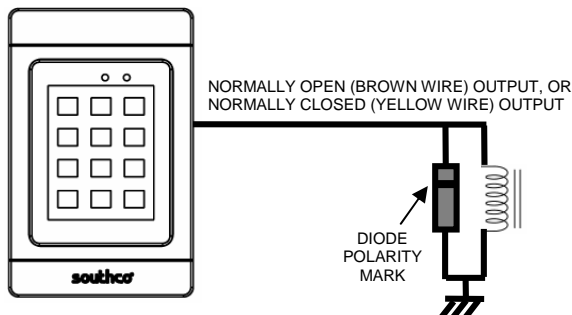

Wiring Diagram

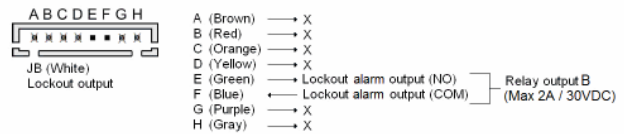
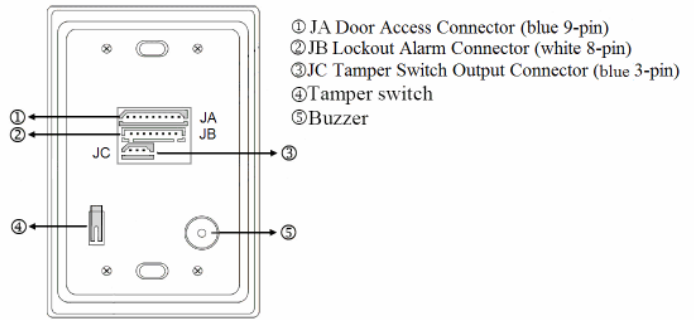

All leads marked with an "X" are not functional.

CAUTION: Product can be damaged if wired incorrectly. Follow wiring diagram above.

CAUTION: A keypad that has been programmed is non-returnable. Please use caution in programming functions so as not to render the keypad unusable.

For technical support of this product contact: info@southco.com or visit: www.southco.com

EA-K1-02x Keypad Operating Instructions

Package Contents

- Standalone keypad
- Wire harness for JA connector (9-wires with blue connector)
- Wire harness for JB connector (8-wires with white connector)
- Wire harness for JC connector (3-wires with blue connector)
- 1 diode
- 2 mounting screws
- Operating instructions

EA-K1 Standalone Keypad Access Controller

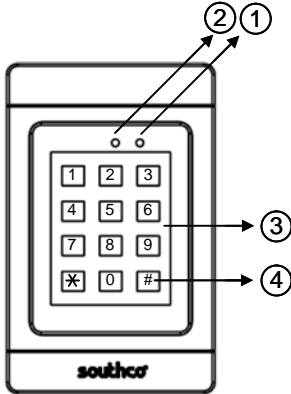

1. Power LED
2. Status LED
 - a. Solid Green: waiting for key code
 - b. Flashing Green: release door
 - c. Flashing Green and Red: programming
3. Keypad
4. Command exit

Features

- Supports 2-latch access with 150 user access codes
- Programmable door release time (1 to 99 seconds)
- Programmable user and instruction code length (5 to 8 digits)
- LED indicators: Power and Status
- Non-volatile memory will retain data when power is removed
- Tamper switch
- For indoor use only

Specifications

| | |
|------------------------|---------------------------------|
| Access Code Length: | Programmable 5 to 8 digits |
| Monitoring Inputs: | Auxiliary (x2) Tamper Switch |
| Supply Voltage: | 12 ± 10% VDC |
| Standby Current: | 25mA (max, no attached devices) |
| Operating Current: | 65mA (max, no attached devices) |
| Operating Temperature: | 0-50 °C |
| Operating Humidity: | 20-90% RH, No condensation |
| Dimensions: | 118 mm x 75 mm x 19 mm |

Controller Mounting and Installation

Please refer to Southco trade drawing J-EA-K1-02 for mounting and installation details.

Modes of Operation

There are two modes of operation for this access controller:

1. User Mode – In this mode, access will be granted when a valid access code is entered or the auxiliary input asserted. An access code ending in an odd number will open the latch connected to the JA connector. An access code ending in an even number will open the latch connected to the JB connector.
2. Programming Mode – In this mode, the controller's settings can be set by the supervisor.

Types of Codes

There are three types of codes for this access controller:

1. Access Code – The controller allows for 150 user access codes. When a programmed access code is entered, the controller will grant access. Access codes cannot begin with a "9".
2. Supervisor Code – There is one supervisor code. This code is used to program the controller and cannot be used as an access code. The supervisor code cannot begin with a "9".
3. Instruction Code – These are used to program the various settings of the controller. The instruction codes are listed in the table below.

| Instruction Codes | |
|------------------------------------|---------------|
| Programming the Supervisor Code | 99998 |
| Enrolling or Changing Access Codes | 99001 - 99150 |
| Programming Access Code Length | 99505 – 99508 |
| Programming Door Release Time | 99801 – 99899 |
| Resetting the Controller | 99990 |

Default Settings

| Default Settings | |
|--------------------|-----------|
| Access code length | 5 digits |
| Door release time | 5 seconds |
| Supervisor code | 12345678 |

Programming the Supervisor Code

The controller is shipped with the default supervisor code (12345678) pre-programmed. To change the supervisor code:

1. Enter instruction code "99998". The Status LED will flash green, blink red, and then become solid green.
2. Enter the current eight digit supervisor code. The Status LED will blink once.
3. Enter the new eight digit supervisor code. The supervisor code **cannot** begin with nine (nine is reserved for instruction codes). The Status LED will flash red then turn off.

⚠ WARNING: If the supervisor code is lost, forgotten or incorrectly entered while programming, the keypad cannot be restored to default settings, no new programming codes may be entered, and the lost supervisor code cannot be recovered. Without the supervisor code, the keypad will continue to function. However, no programming changes can be made.

Enrolling or Changing Access Codes

The controller supports up to 150 user access codes. Access codes that end in an odd number will allow access to the latch connected to the JA connector. Access codes that end in an even number will allow access to the latch connected to the JB connector.

The access codes can be any combination of digits, except the access codes **cannot** begin with nine (nine is reserved for instruction codes). To enroll or change an access code:

1. Enter one of the 150 instruction codes for enrolling access codes (i.e. 99001 through 99150). The Status LED will flash green, flash red, and then remain green.
2. Enter the supervisor code. The Status LED will blink once.
3. Enter the access code. The Status LED will flash red twice, and then turn off.

To change a user access code, use the programming code that it is paired with. For example, if 99001 had been used to assign the user access code 12345, you may change this user access code to 54321 by using the instruction code 99001. It is recommended that the supervisor keep careful records of each access code and its corresponding instruction code.

Programming Door Release Time

The length of time the door is released can be programmed from 1 to 99 seconds.

To change from the default of five seconds:

1. Enter "998tt", where "tt" is the door release code in seconds. The Status LED will flash green, flash red, and then become solid green.
2. Enter the supervisor code. The Status LED will flash red, then green before turning off.

Programming Code Length

The number of digits in the access and instruction codes can be changed from the default of five. The number of digits set here is the number of digits the keypad accepts for both access and instruction codes. If the number of digits is increased, then the function code must be padded with zeroes. For example if the number of digits has been changed from five to eight, the code to reset the controller (99990) must be entered as "99990000".

NOTE: The supervisor code cannot be adjusted; it is always an eight digit code.

To change from the default of five digits:

1. Enter "9950x", where "x" is the number of digits in the user access code (ranging from 5 to 8). The Status LED will flash green, flash red, and then become solid green.
2. Enter the eight digit supervisor code. The Status LED will flash red, then green before turning off.

⚠ NOTE: Changing the code length will not delete programmed access codes. However, changing the code length to be longer than access codes already stored in memory will result in the access codes being unusable. For example, if a five digit access code is stored in memory, and the code length is then changed to eight, the access code cannot be used.

If the code length is changed to be shorter than access codes already enrolled, then the last digit of the shortened access code will determine which latch is opened. For example, if an access code is 87654321, the controller will open the latch connected to the JA connector since the access code ends in an odd digit. If the code length is changed to seven digits, then this access code will be shortened to 8765432 and open the latch connected to the JB connector since the access code now ends in an even digit

Resetting the Controller

The controller can be set to its factory default settings. To restore the default settings:

EA-K1-02x Keypad Operating Instructions

1. Enter the programming code 99990.
2. Enter the supervisor access code.

The Status LED will flash red twice and then turn off indicating the programming is complete.

NOTE: This will erase all programmed user access codes.

Other Features

Auxiliary Inputs

The EA-K1-02x controller has two auxiliary inputs.

One input can be driven by an external device to grant access to the latch connected to the JA connector. Pin 4 from the JA connector (green wire) is the auxiliary input. When the auxiliary input is 12VDC, the controller will grant access for the programmed access time.

The other input can be driven by an external device to grant access to the latch connected to the JB connector. Pin 2 from the JA connector (purple wire) is the auxiliary input for the JB connector. When the security monitor input is LOW (0V), the controller will grant access for the programmed access time.

Tamper Switch

The JC connector can be used to monitor the status of the tamper switch. When the tamper switch is closed, the NO signal will be driven to the same voltage level as the COM signal. When the tamper switch is open, the NC signal will be driven to the same voltage level as the COM signal.

Wiring Multiple Controllers

A diode is provided with the EA-K1-02x controller. The diode allows for a keypad to be isolated when multiple controllers are connected to the same latch. Refer to the figure below for wiring details when using the diode when using multiple controllers.

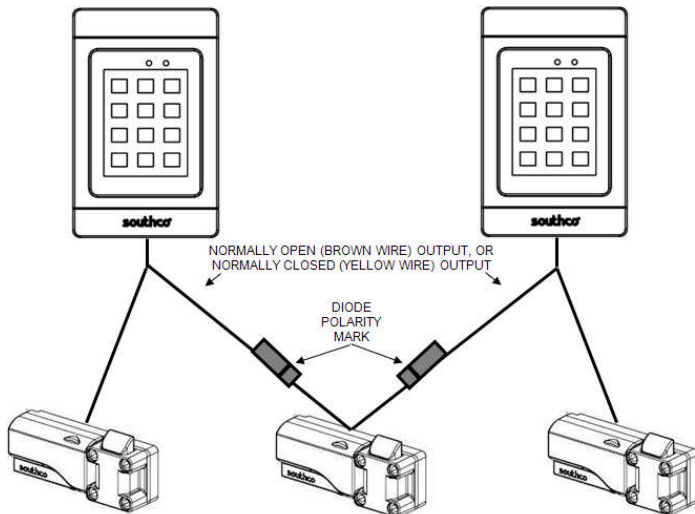

Connecting to an Inductive Load

A diode is provided with the EA-K1-02x controller. This diode should be used when connecting to a device with an inductive load (for example, a

relay or door strike) to protect the controller from a reverse voltage spike. The diode should be placed in parallel with the coil, as shown in the figure below.

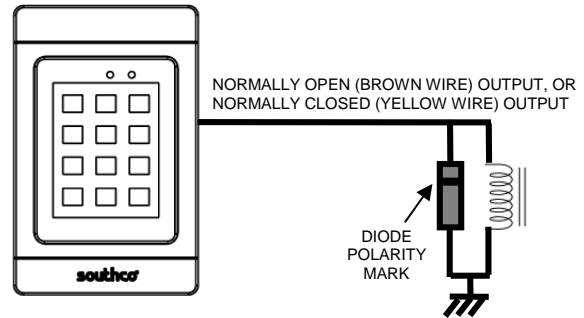

Wiring Diagram

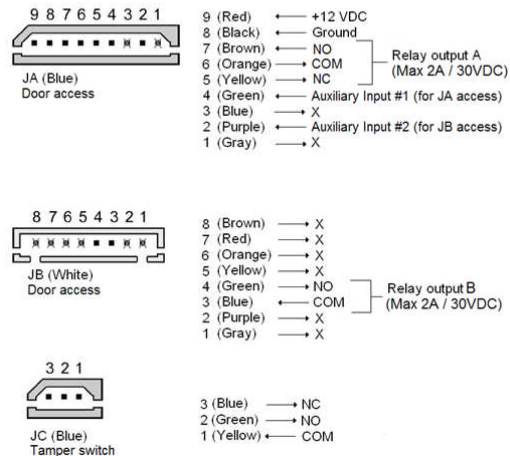
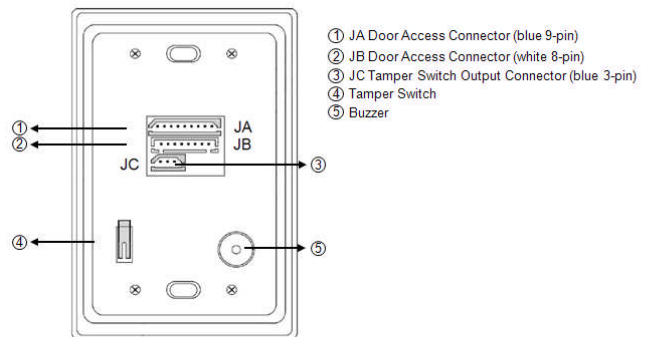

All leads marked with an "X" are not functional.

CAUTION: A keypad that has been programmed is non-returnable. Please use caution in programming functions so as not to render the keypad unusable.

For technical support of this product contact: info@southco.com or visit: www.southco.com